



## M03

### FLOOR TO CEILING MOUNTED WARDROBE SLIDING DOOR SYSTEM

Regular “inside fit” system. Fits top and bottom inside the opening - for wardrobe carcass or floor to ceiling.

- Applications:** Wardrobe sliding doors  
2, 3, or 4 door systems - available as kits or with complete built up doors to size
- Door Types:** Glass, mirror and wood (see page 16)
- Door Thickness:** 16mm to 22mm
- Door Weight:** Up to 60 kg's      **Min Door Weight:** 22 kg's
- Door Size:** 2440mm x 1200mm (recommended)
- Door Height:** Up to 2500mm      **Door Width:** 600mm to 1200mm

Integrated Soft Close comes standard on all doors - opening and closing  
Easy soft close adjustment  
Smooth sliding action with easy height adjustment  
The principles of level, plumb and square apply for all types of sliding doors.  
We recommend that you do not rely on walls, floors and ceilings to be perfect. It is best to build a carcass for your sliding doors wherever possible.

#### VS\_M03.2DR

Complete system: Top and bottom track 3m, wheel sets and soft closers for 2 doors

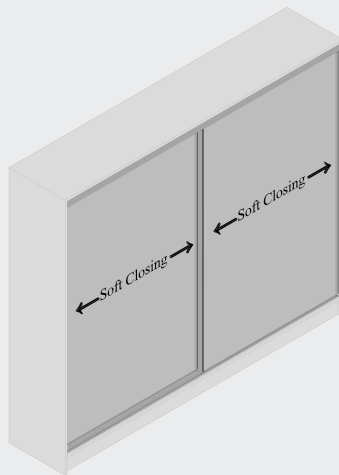

#### VS\_M03.3DR

Complete system: Top and bottom track 3m, wheel sets and soft closers for 3 doors

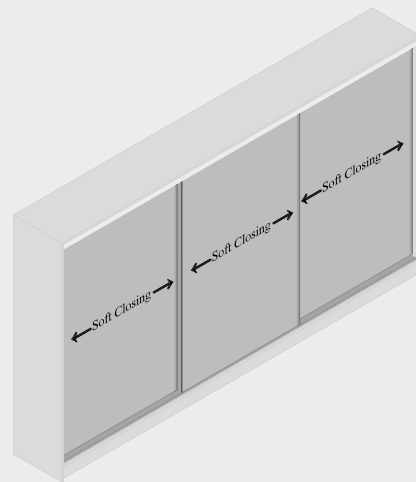

### HOW TO WORK OUT YOUR DOOR HEIGHT

Door height = inside height - 40mm  
Door size guideline using the aspect ratio

height ÷ width = Aspect ratio

1800	÷	700	=	2.57
2100	÷	800	=	2.63
2300	÷	900	=	2.55
2400	÷	1000	=	2.4
2600	÷	1100	=	2.36

Aspect ratio's should be 3.35 or less, for the doors to function correctly, on the M03 system.

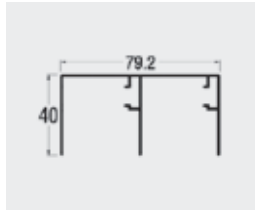
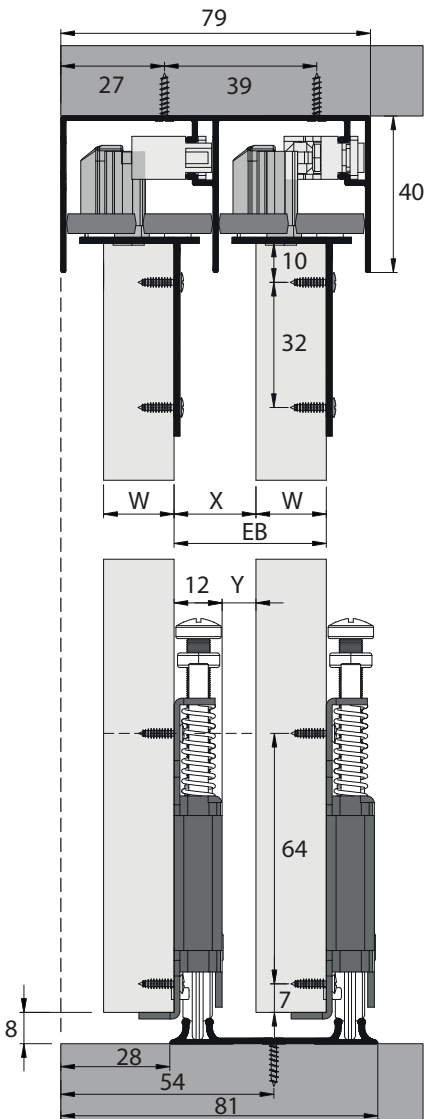

**Top Track 3m**  
VS\_M03\_TTRACK3M

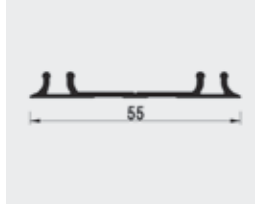

**Bottom Track 3m**  
VS\_M03\_BTRACK3M

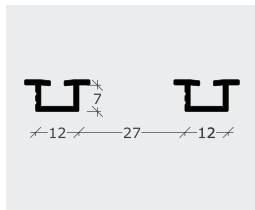

**Insert Track 3m**  
VS\_INS.TRACK3M - insert track  
for M03 & M04

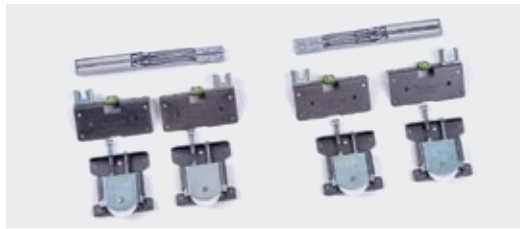

**2 Door Wheel Set  
With Soft Closers**  
VS\_M03\_WS.2DR



**3 Door Wheel Set  
With Soft Closers**  
VS\_M03\_WS.3DR

